

VAMOS A TRAZAR

● REPASEN LOS CAMINOS.

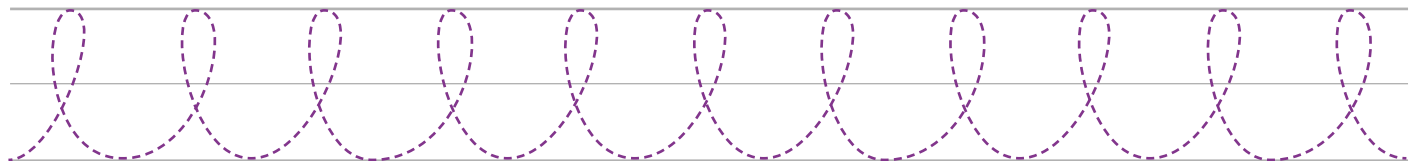
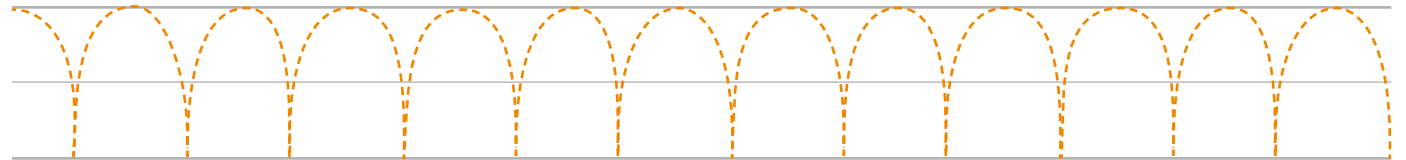
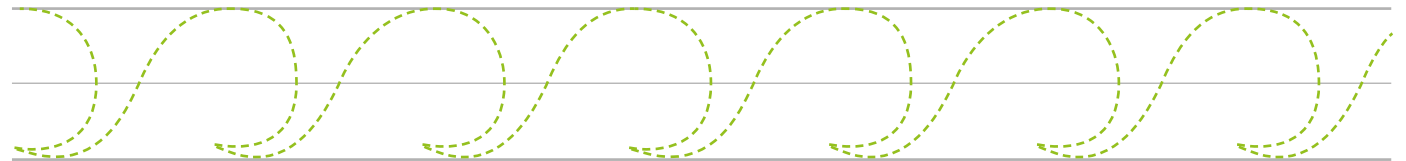
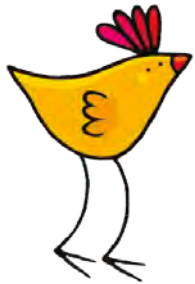
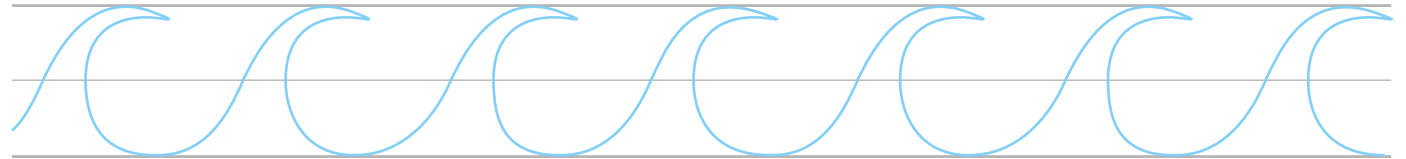
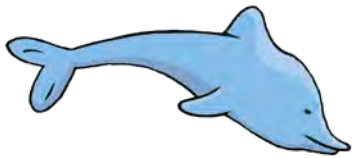

VAMOS A TRAZAR

● REPASEN LOS CAMINOS.

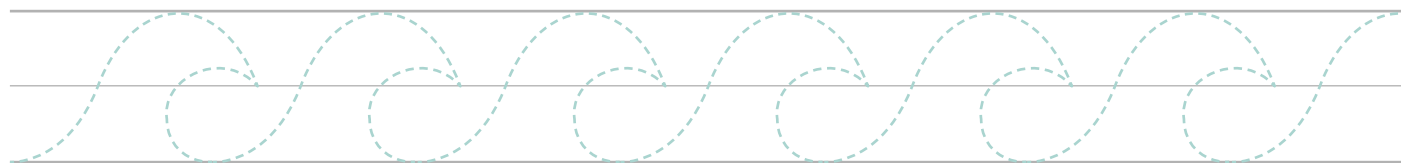
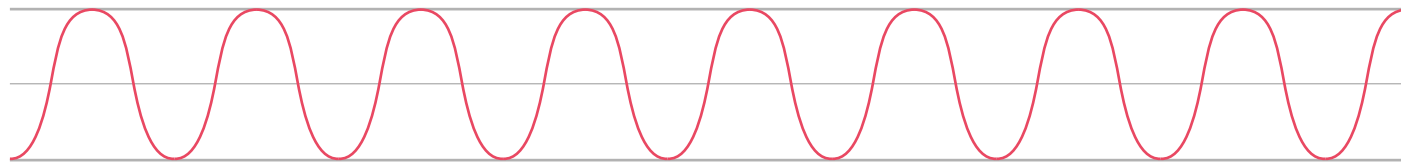

VAMOS A COLOREAR LAS VOCALES

● PINTEN DE UN COLOR DIFERENTE CADA VOCAL.



A large light blue rounded rectangle containing three large white outline letters: 'A', 'E', and 'O'. The letters are surrounded by a field of small, colorful stars and crosses in shades of pink, yellow, blue, and grey, intended for coloring.

Ficha

4

GRAFISMOS

VAMOS A COLOREAR LAS VOCALES

● PINTEN DE UN COLOR DIFERENTE CADA VOCAL.

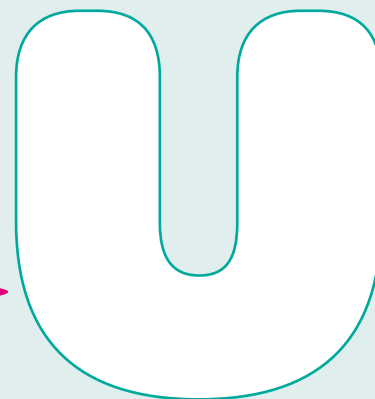
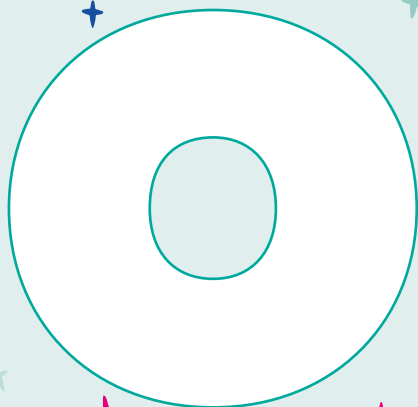

CON A DE...

● PINTEN EL DIBUJO, REPASEN LAS LETRAS Y COMPLETEN LOS RENGLONES.

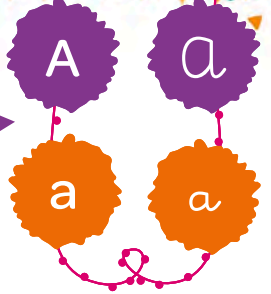

A A

a a

a a

a a

ÁRBOL

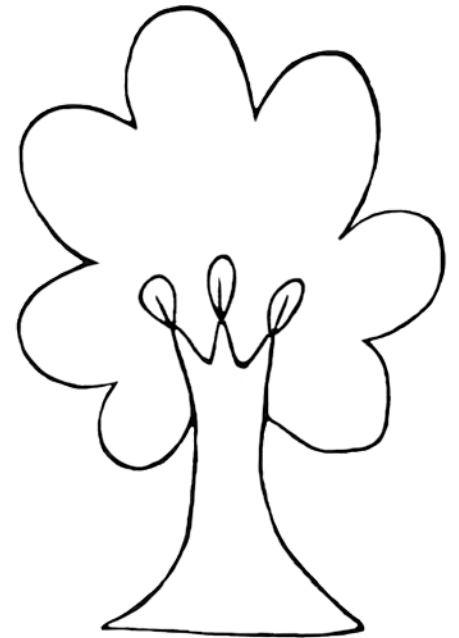

CON E DE...

● PINTEN EL DIBUJO, REPASEN LAS LETRAS Y COMPLETEN LOS RENGLONES.

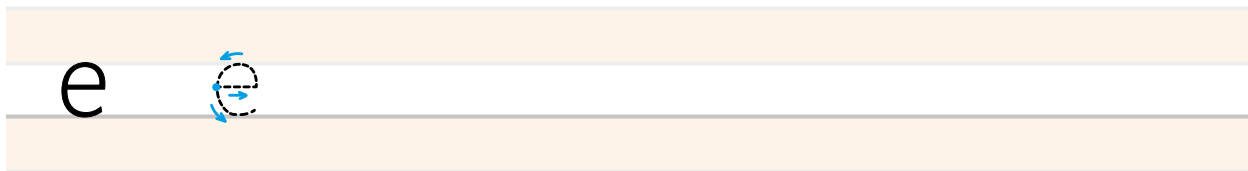
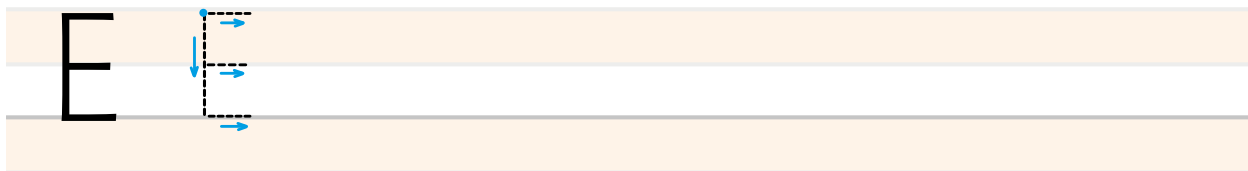
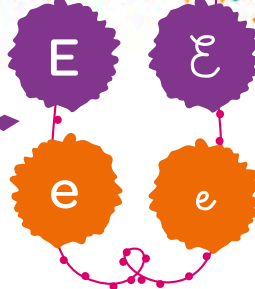

ELEFANTE

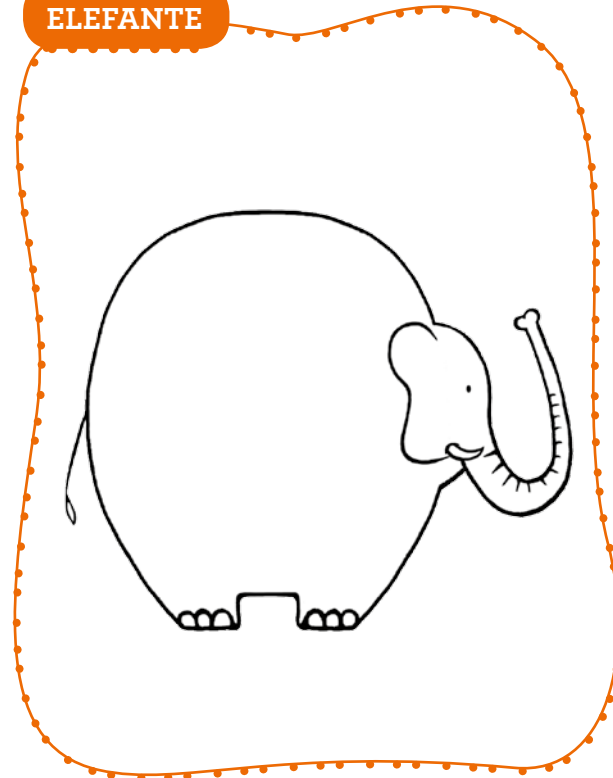

CON I DE...

PINTEN EL DIBUJO, REPASEN LAS LETRAS Y COMPLETEN LOS RENGLONES.

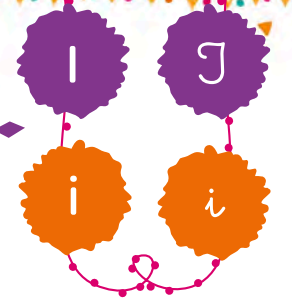

Handwriting practice lines for uppercase 'I' and lowercase 'i'. Each row shows a solid letter followed by a dashed letter with blue arrows indicating stroke direction. The rows are: 1) Uppercase 'I', 2) Lowercase 'i', 3) Uppercase 'J', 4) Lowercase 'j'. Below each row are two blank lines for practice.

IMÁN

CON O DE...

PINTEN EL DIBUJO, REPASEN LAS LETRAS Y COMPLETEN LOS RENGLONES.

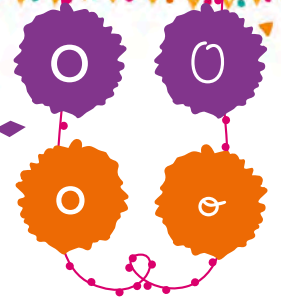

Handwriting practice lines with stroke order guides for uppercase O and lowercase o.

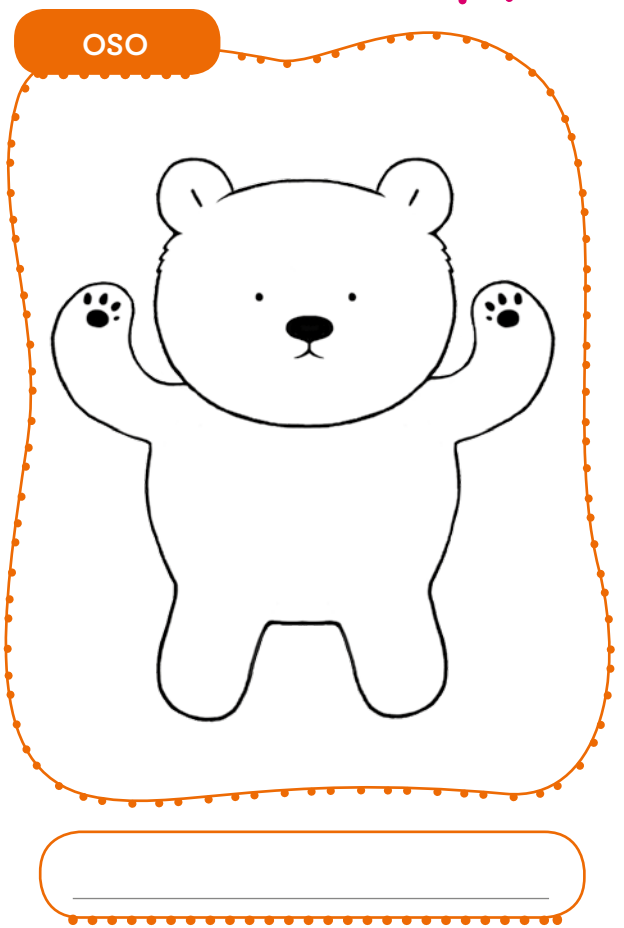

CON U DE...

● PINTEN EL DIBUJO, REPASEN LAS LETRAS Y COMPLETEN LOS RENGLONES.

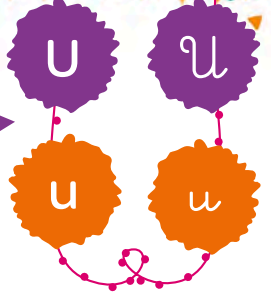

U U

u u

u u

u u

UVA

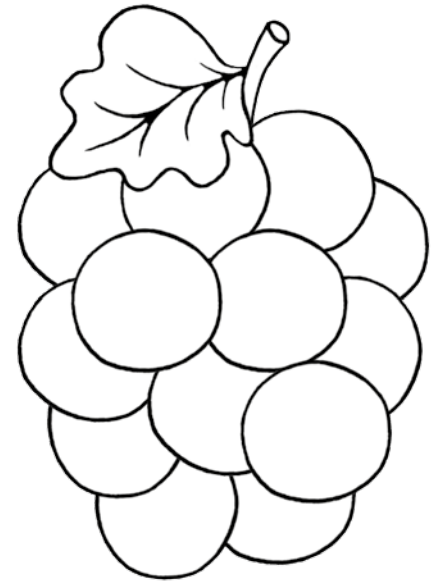

CON B DE...

● PINTEN EL DIBUJO, REPASEN LAS LETRAS Y COMPLETEN LOS RENGLONES.

B

B

b

b

B B

b b

B B

b b

BARCO

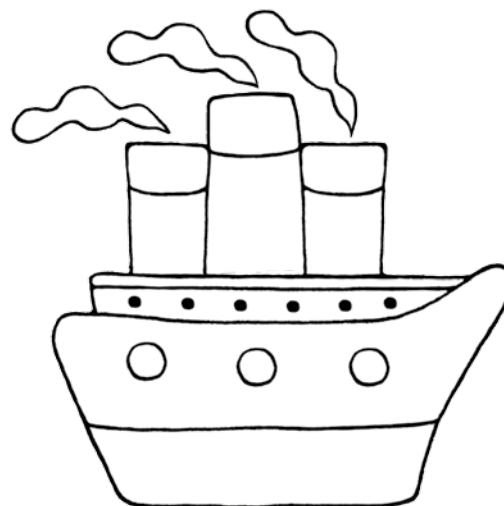

CON C DE...

● PINTEN EL DIBUJO, REPASEN LAS LETRAS Y COMPLETEN LOS RENGLONES.

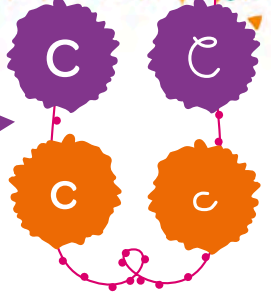

C C

c c

c c

c c

CARACOL

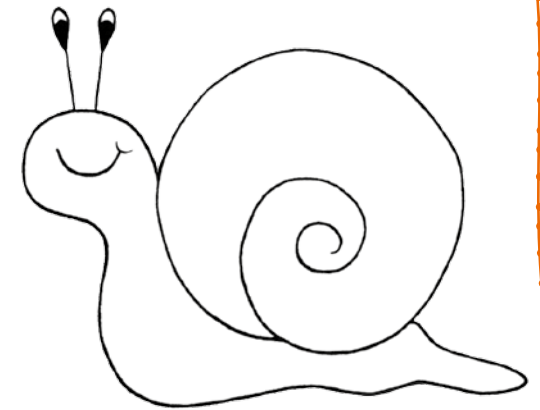

CON D DE...

● PINTEN EL DIBUJO, REPASEN LAS LETRAS Y COMPLETEN LOS RENGLONES.

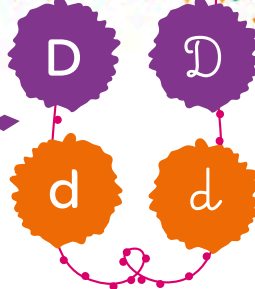

Handwriting practice lines for the letter 'D'. Each row contains a solid letter followed by a dashed letter with blue arrows indicating the stroke direction. The rows are: 1. Uppercase 'D' and dashed 'D'. 2. Lowercase 'd' and dashed 'd'. 3. Cursive uppercase 'D' and dashed cursive 'D'. 4. Cursive lowercase 'd' and dashed cursive 'd'. Below each row are two empty lines for independent practice.

DINOSAURIO

A line drawing of a long-necked dinosaur (sauropod) standing and facing left. The drawing is enclosed in a decorative orange border with a dotted pattern. Below the dinosaur is a blank rounded rectangular box for coloring or labeling.

CON F DE...

● PINTEN EL DIBUJO, REPASEN LAS LETRAS Y COMPLETEN LOS RENGLONES.

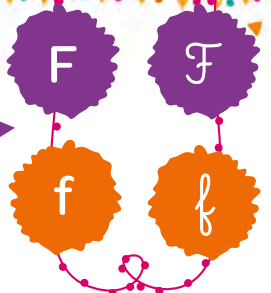

Handwriting practice area with four rows of horizontal lines. Each row contains a solid letter followed by a dashed letter with blue arrows indicating stroke direction:

- Row 1: Uppercase 'F' and dashed 'F'.
- Row 2: Lowercase 'f' and dashed 'f'.
- Row 3: Uppercase 'F' and dashed 'F'.
- Row 4: Lowercase 'f' and dashed 'f'.

Activity area for coloring and writing. It features a rounded rectangular frame with a dotted orange border. At the top left of the frame is a small orange tab with the word "FLOR" in white capital letters. Inside the frame is a black-and-white line drawing of a flower with five petals, a stem, and two leaves. Below the frame is a horizontal line for writing.

CON G DE...

● PINTEN EL DIBUJO, REPASEN LAS LETRAS Y COMPLETEN LOS RENGLONES.

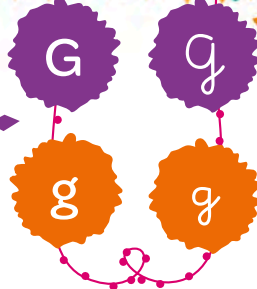

G G

g g

g g

g g

GATO



CON H DE...

● PINTEN EL DIBUJO, REPASEN LAS LETRAS Y COMPLETEN LOS RENGLONES.

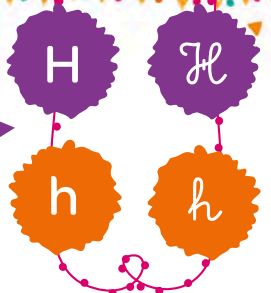

H H

h h

H H

h h

HELADO

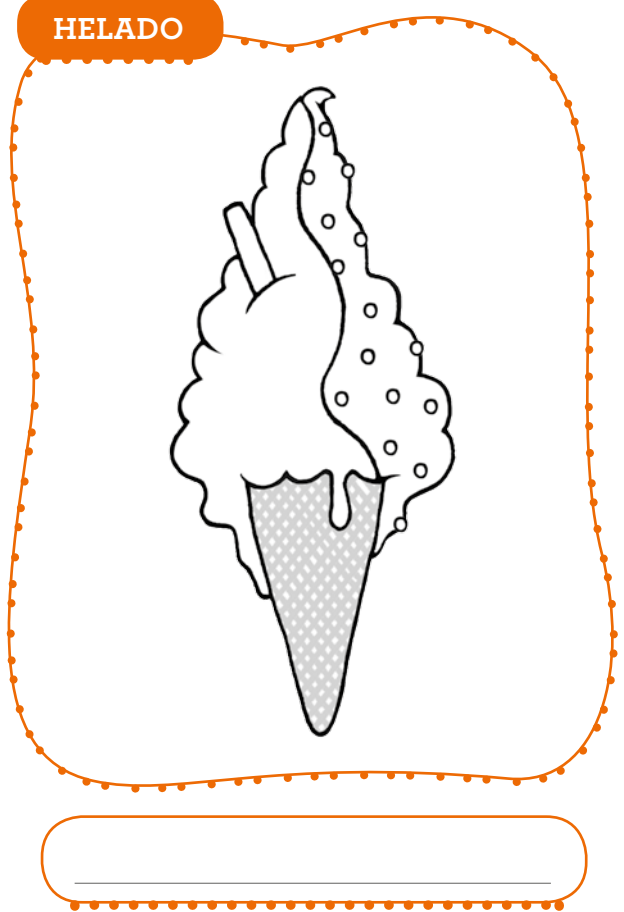

CON J DE...

● PINTEN EL DIBUJO, REPASEN LAS LETRAS Y COMPLETEN LOS RENGLONES.

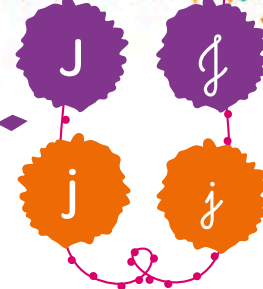

Handwriting practice lines for the letter 'J'. Each row contains a solid letter followed by a dashed letter with blue arrows indicating stroke direction.

- Row 1: Uppercase 'J' and dashed 'J' with a downward arrow.
- Row 2: Lowercase 'j' and dashed 'j' with a downward arrow.
- Row 3: Uppercase 'J' with a hook and dashed 'J' with a hook and downward arrow.
- Row 4: Lowercase 'j' with a hook and dashed 'j' with a hook and downward arrow.

JIRAFÁ

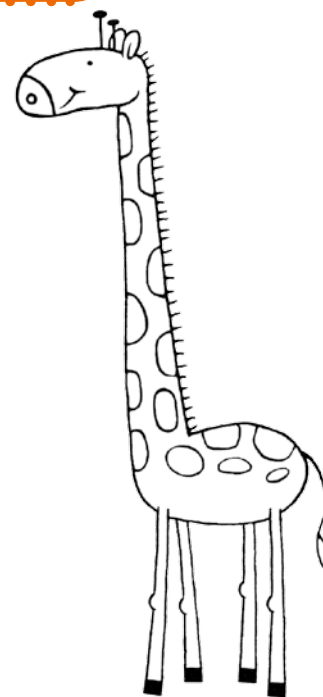

CON K DE...

● PINTEN EL DIBUJO, REPASEN LAS LETRAS Y COMPLETEN LOS RENGLONES.

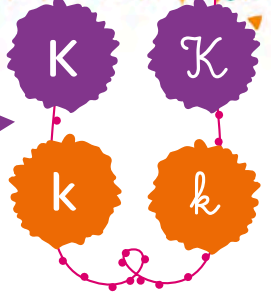

Handwriting practice lines for the letter 'K'. Each row contains a solid letter followed by a dashed letter with blue arrows indicating stroke direction. The rows are: uppercase 'K', lowercase 'k', cursive uppercase 'K', and cursive lowercase 'k'. Below each row are empty lines for practice.

KIWI

A line drawing of three kiwi fruits. One is whole, and two are sliced to show the green flesh and black seeds. The drawing is enclosed in a decorative orange dotted border.

CON L DE...

● PINTEN EL DIBUJO, REPASEN LAS LETRAS Y COMPLETEN LOS RENGLONES.

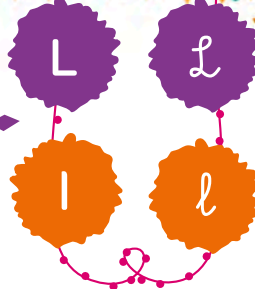

Handwriting practice area with four rows of horizontal lines. Each row contains a solid letter followed by a dashed letter with blue arrows indicating stroke direction. The letters are: uppercase 'L', lowercase 'l', uppercase 'L', and lowercase 'l'.

LEÓN

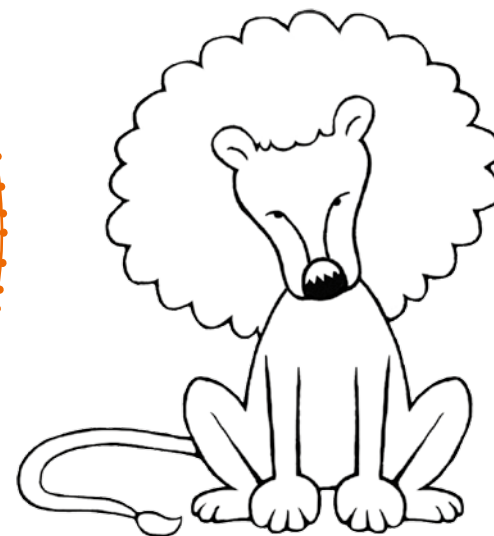

A horizontal line inside a rounded rectangular box, intended for the student to write the name of the animal.

CON M DE...

● PINTEN EL DIBUJO, REPASEN LAS LETRAS Y COMPLETEN LOS RENGLONES.

M

m

m

m

M M

m m

m m

m m

MONO

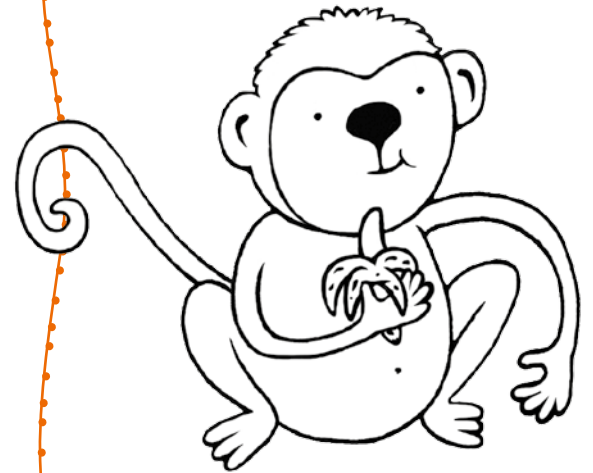

CON N DE...

● PINTEN EL DIBUJO, REPASEN LAS LETRAS Y COMPLETEN LOS RENGLONES.

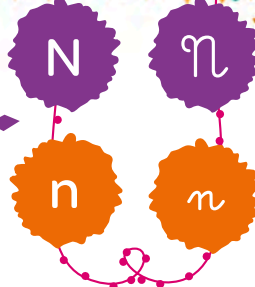

Handwriting practice lines for uppercase N and lowercase n. Each row shows a solid letter followed by a dashed letter with blue arrows indicating stroke direction.

Row 1: Uppercase N (solid and dashed with stroke arrows)

Row 2: Lowercase n (solid and dashed with stroke arrows)

Row 3: Uppercase N (solid and dashed with stroke arrows)

Row 4: Lowercase n (solid and dashed with stroke arrows)

Activity area for coloring and writing. It features a cloud with a smiling face, a label 'NUBE' in an orange bubble, and a blank line for writing.

NUBE

CON Ñ DE...

● PINTEN EL DIBUJO, REPASEN LAS LETRAS Y COMPLETEN LOS RENGLONES.

Ñ

ñ

ñ

ñ

Ñ Ñ

ñ ñ

ñ ñ

ñ ñ

ÑANDÚ

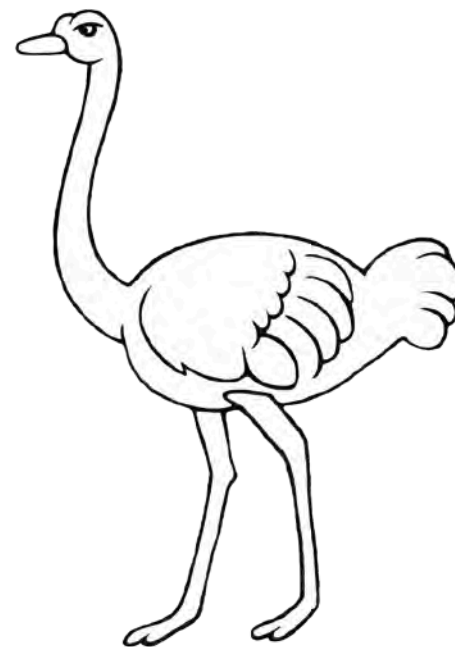

CON P DE...

● PINTEN EL DIBUJO, REPASEN LAS LETRAS Y COMPLETEN LOS RENGLONES.

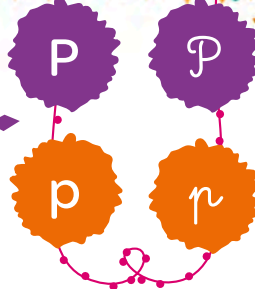

Handwriting practice lines for the letter 'P'. Each row contains a solid letter followed by a dashed letter with blue arrows indicating stroke direction. The rows are: uppercase 'P', lowercase 'p', uppercase 'P', and lowercase 'p'.

POTRILLO

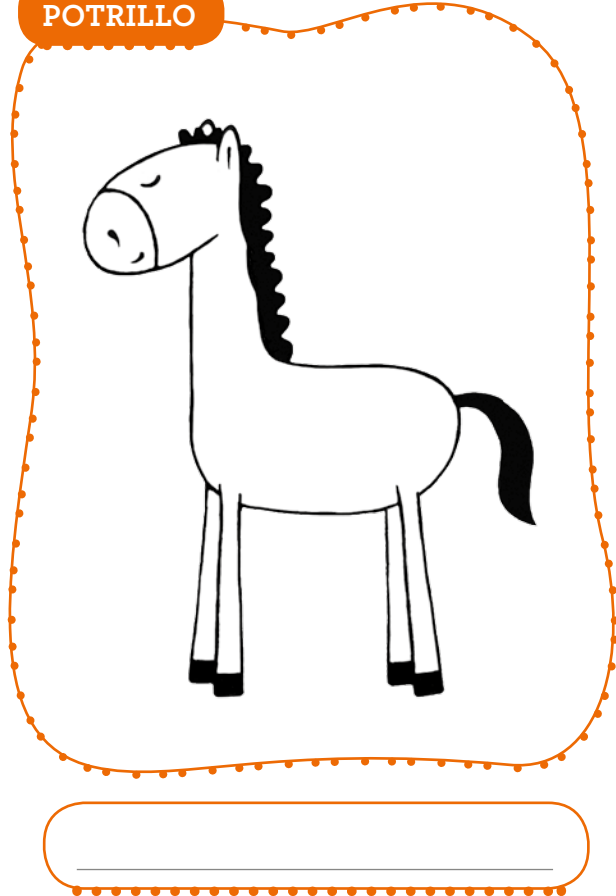

CON Q DE...

● PINTEN EL DIBUJO, REPASEN LAS LETRAS Y COMPLETEN LOS RENGLONES.

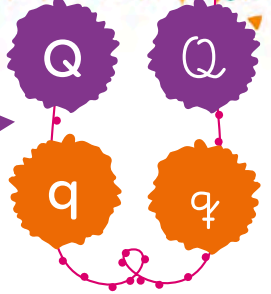

Q Q

q q

Q Q

q q

QUESO

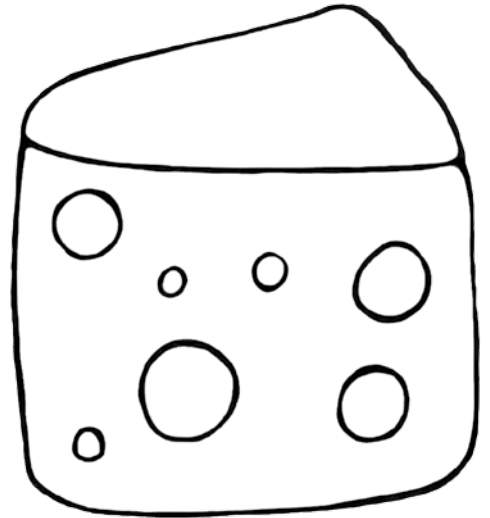

CON R DE...

● PINTEN EL DIBUJO, REPASEN LAS LETRAS Y COMPLETEN LOS RENGLONES.

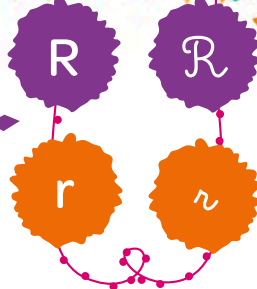

Handwriting practice lines for the letter 'R'. Each row consists of two horizontal lines. The first row shows a solid uppercase 'R' followed by a dashed uppercase 'R' with blue arrows indicating the stroke direction. The second row shows a solid lowercase 'r' followed by a dashed lowercase 'r' with blue arrows. The third row shows a solid cursive uppercase 'R' followed by a dashed cursive uppercase 'R' with blue arrows. The fourth row shows a solid cursive lowercase 'r' followed by a dashed cursive lowercase 'r' with blue arrows. The remaining space in each row is blank for practice.

RATÓN

A simple line drawing of a mouse, facing left. It has a long, curled tail, whiskers, and small ears. The drawing is enclosed in a decorative orange border with a dotted pattern. Below the drawing is a blank orange rounded rectangle for coloring or labeling.

CON S DE...

● PINTEN EL DIBUJO, REPASEN LAS LETRAS Y COMPLETEN LOS RENGLONES.

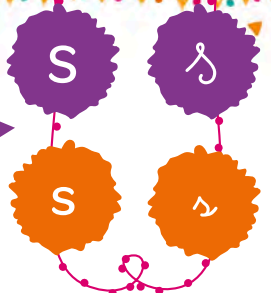

SAPO

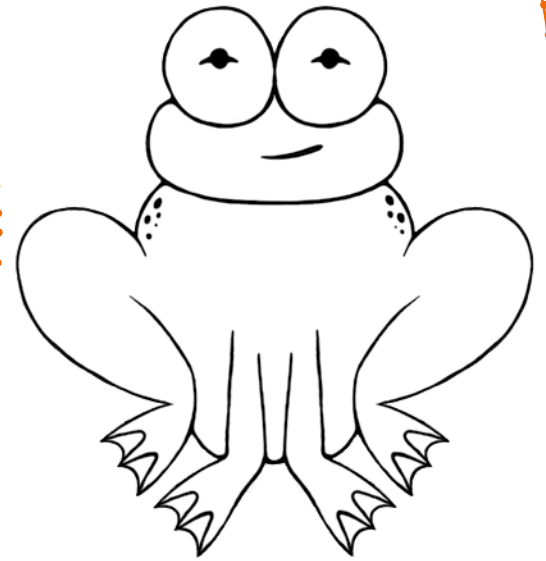

S S

s s

S S

s s

CON T DE...

● PINTEN EL DIBUJO, REPASEN LAS LETRAS Y COMPLETEN LOS RENGLONES.

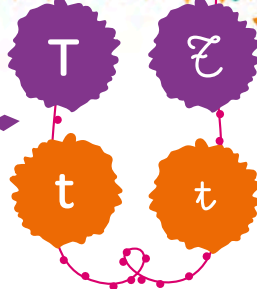

Handwriting practice lines for the letter 'T'. Each row contains a solid letter followed by a dashed letter with blue arrows indicating stroke direction. The first row is for uppercase 'T', the second for lowercase 't', the third for uppercase 'Z', and the fourth for lowercase 'z'. Below each row are two blank lines for independent practice.

TIMÓN

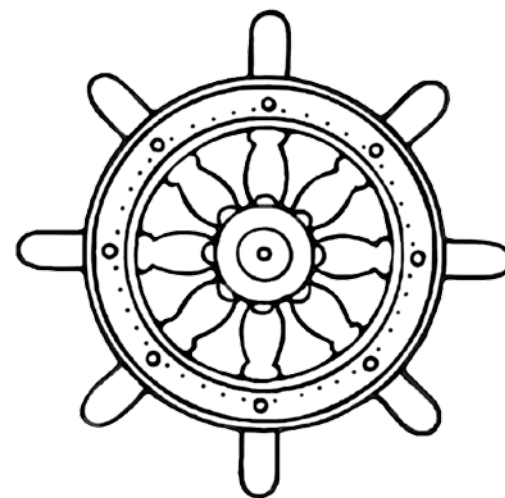

CON V DE...

● PINTEN EL DIBUJO, REPASEN LAS LETRAS Y COMPLETEN LOS RENGLONES.

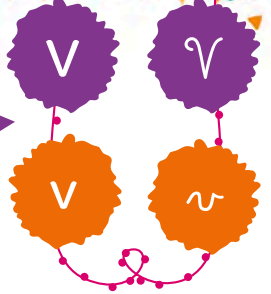

V V

v v

U U

~ ~

VÍBORA

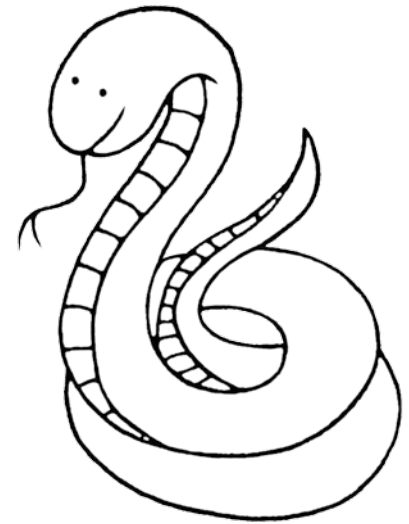

CON W DE...

● PINTEN EL DIBUJO, REPASEN LAS LETRAS Y COMPLETEN LOS RENGLONES.

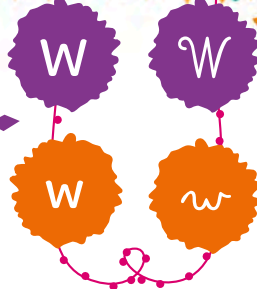

W W

w w

W W

w w

WINDSURF



CON X DE...

● PINTEN EL DIBUJO, REPASEN LAS LETRAS Y COMPLETEN LOS RENGLONES.

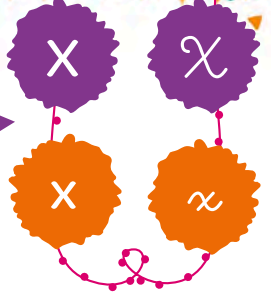

X X

X X

x x

x x

XILOFÓN

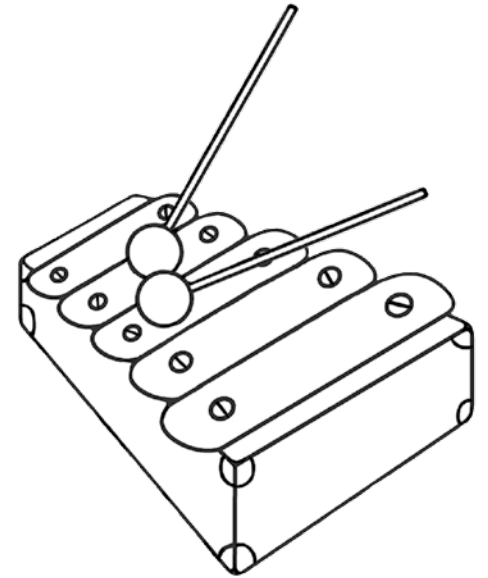

CON Y DE...

● PINTEN EL DIBUJO, REPASEN LAS LETRAS Y COMPLETEN LOS RENGLONES.

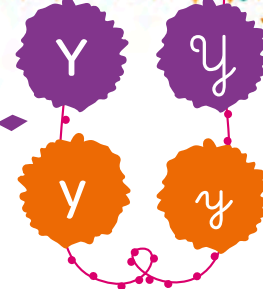

Handwriting practice lines for the letter 'Y'. Each row consists of two horizontal lines. The first row shows a solid uppercase 'Y' followed by a dashed uppercase 'Y' with blue arrows indicating stroke direction. The second row shows a solid lowercase 'y' followed by a dashed lowercase 'y' with blue arrows. The third row shows a solid lowercase 'y' followed by a dashed lowercase 'y' with blue arrows. The fourth row shows a solid lowercase 'y' followed by a dashed lowercase 'y' with blue arrows.

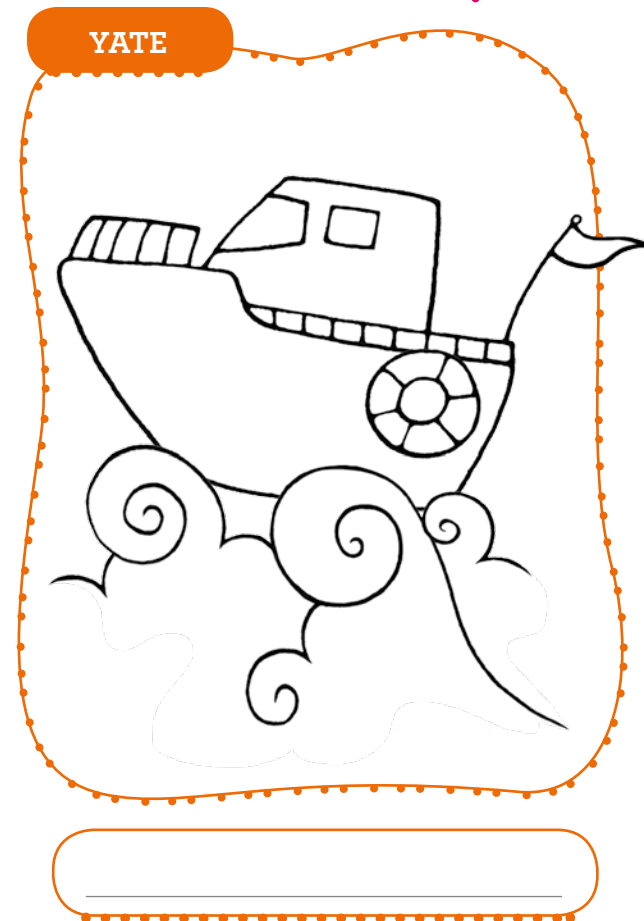

CON Z DE...

● PINTEN EL DIBUJO, REPASEN LAS LETRAS Y COMPLETEN LOS RENGLONES.

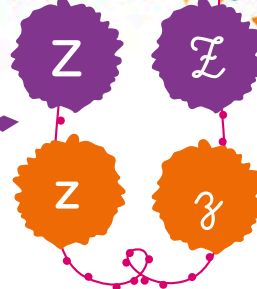

Z Z

Z Z

Z Z

z z

ZORRO

